

Pencil control 1

Name: _____

Start from the dots and carefully trace over the lines from left to right.

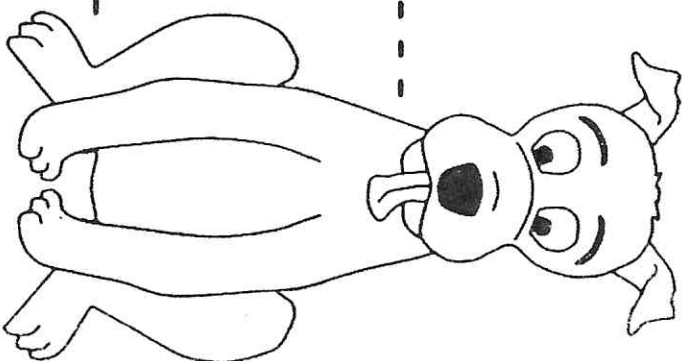

Pencil control 2

Name: _____

Carefully trace over the dotted lines.

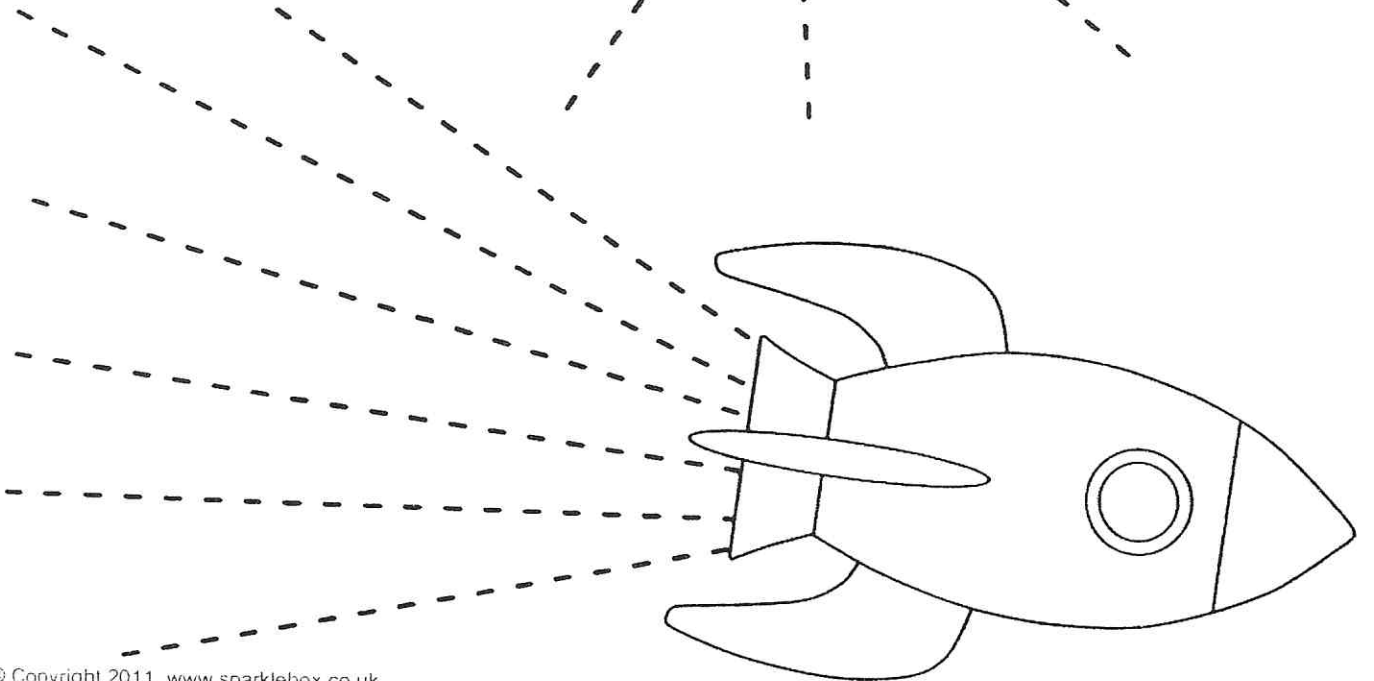
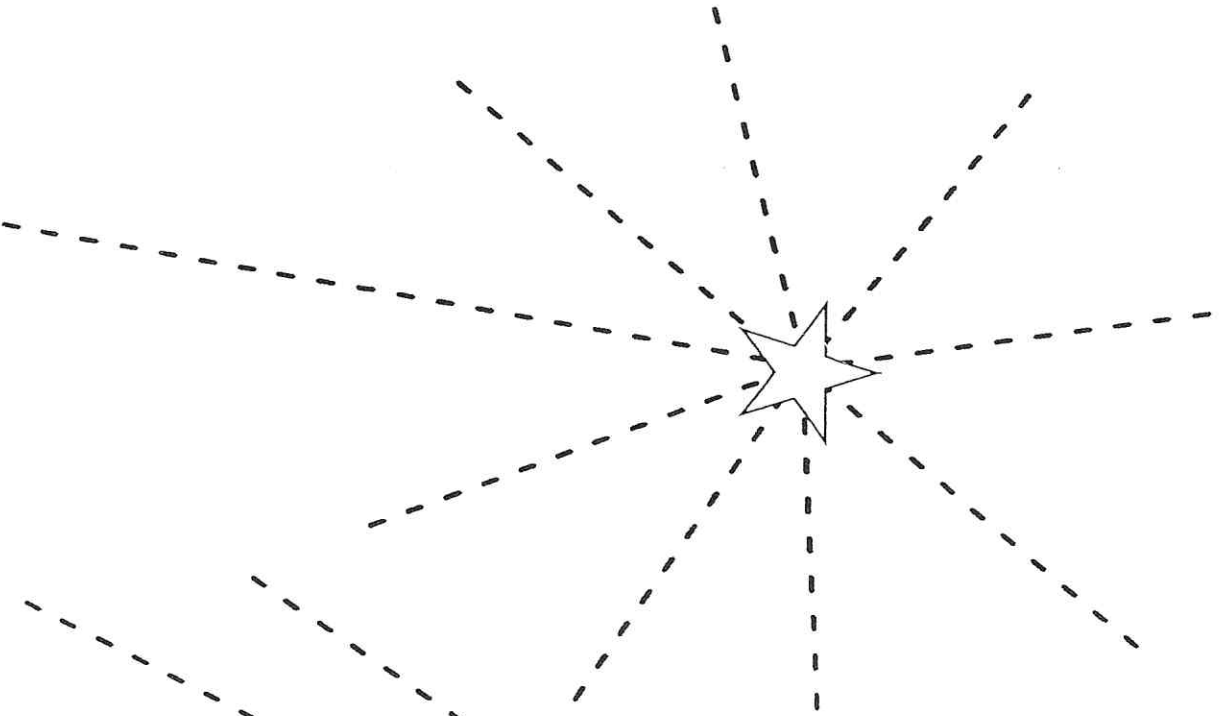
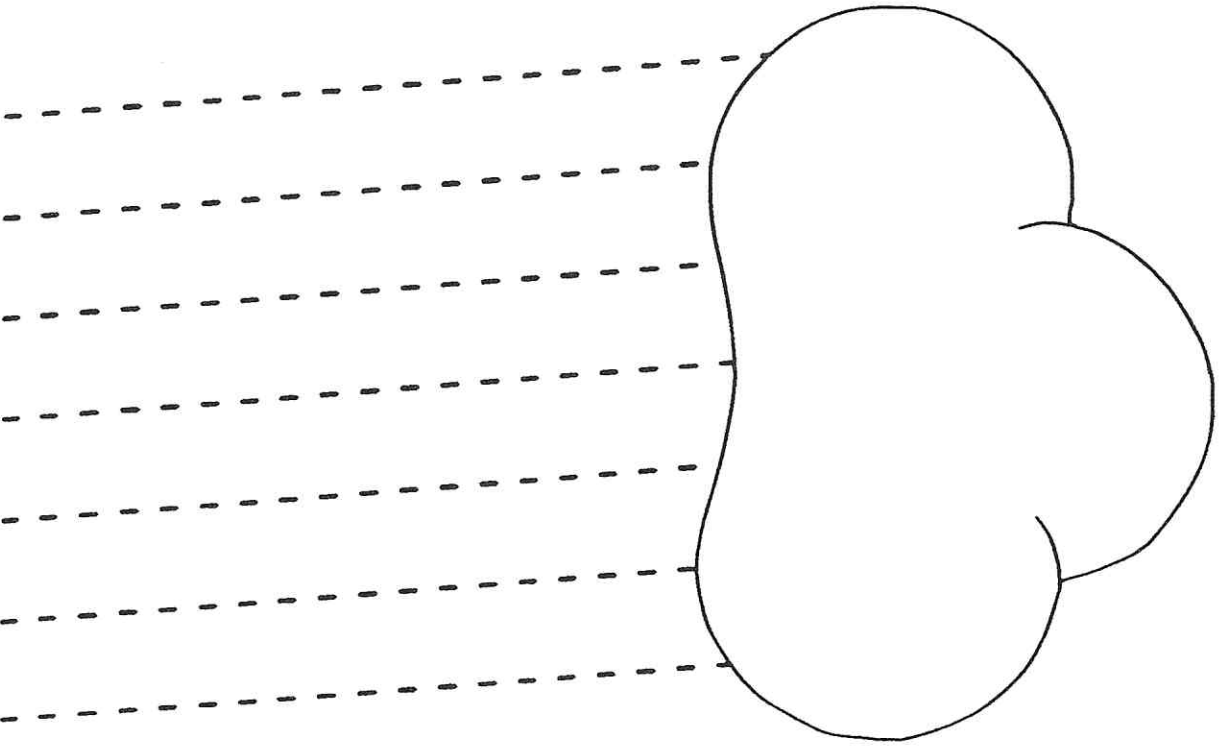

Pencil control 3

Name: _____

Carefully trace over the dotted lines.

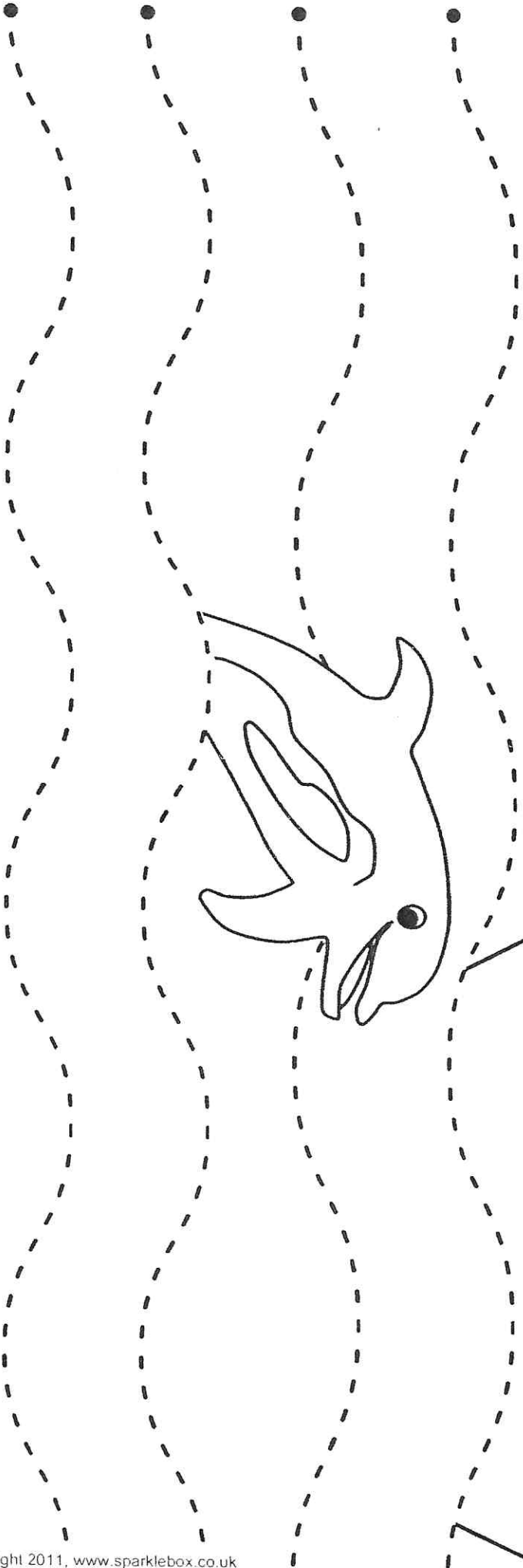
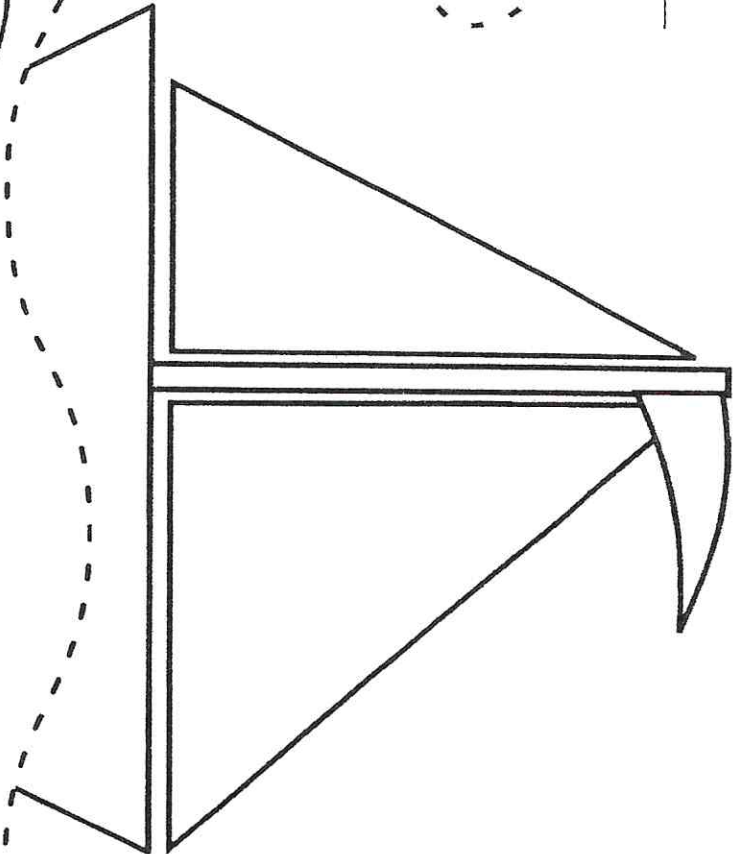
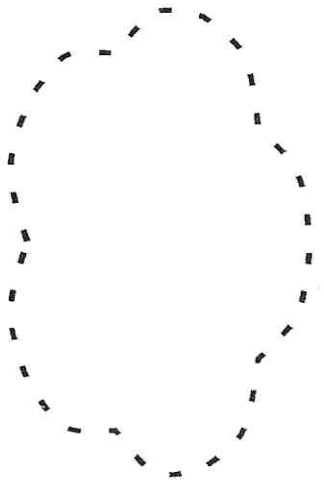
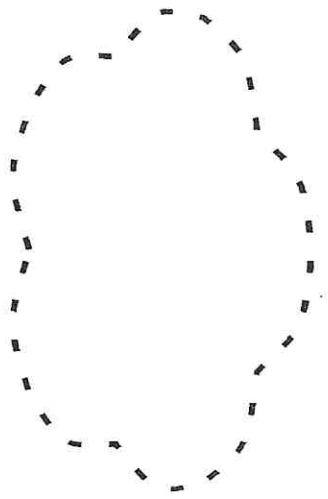

Pencil control 4

Name: _____

Carefully trace over the dotted lines.

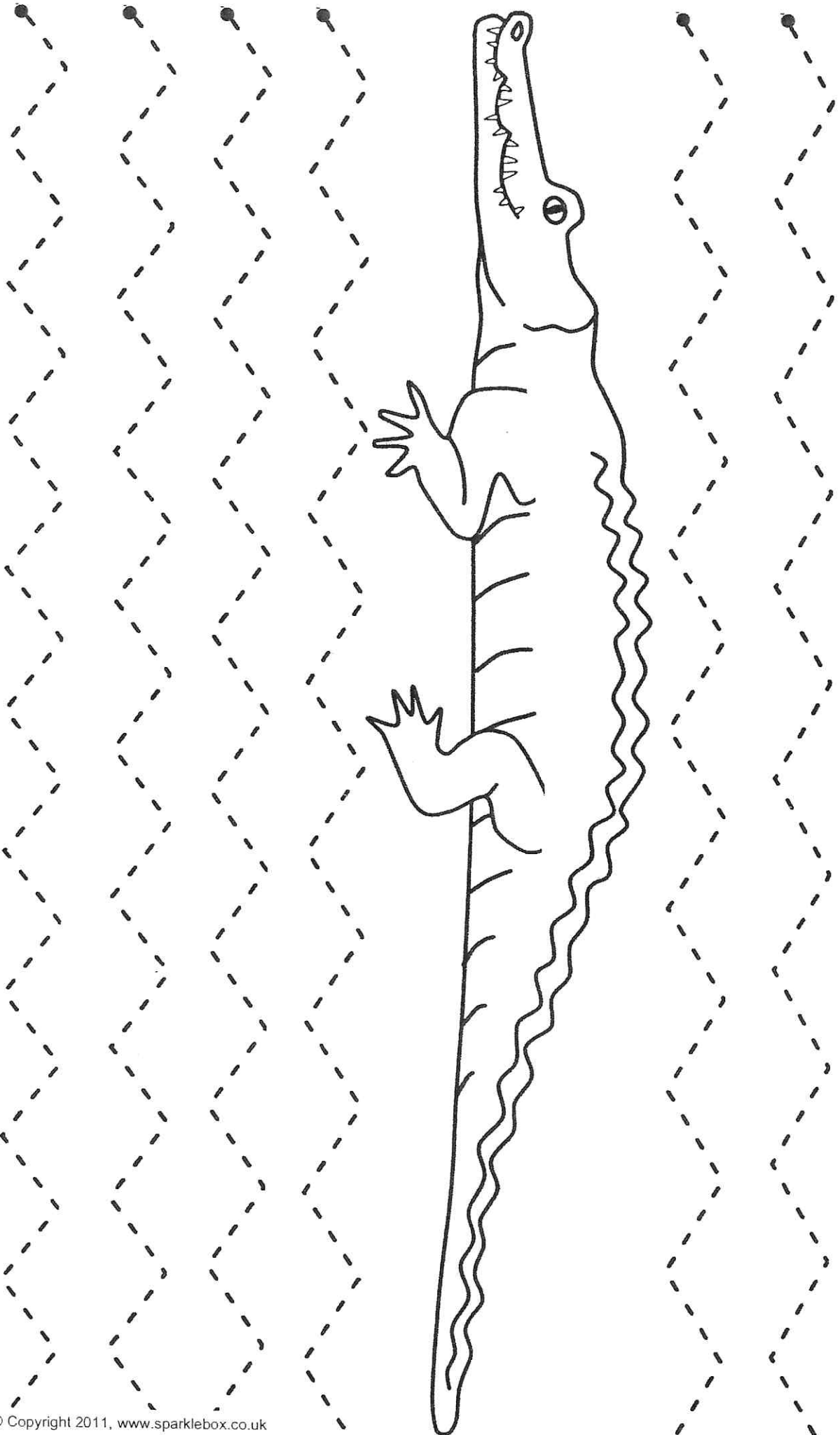
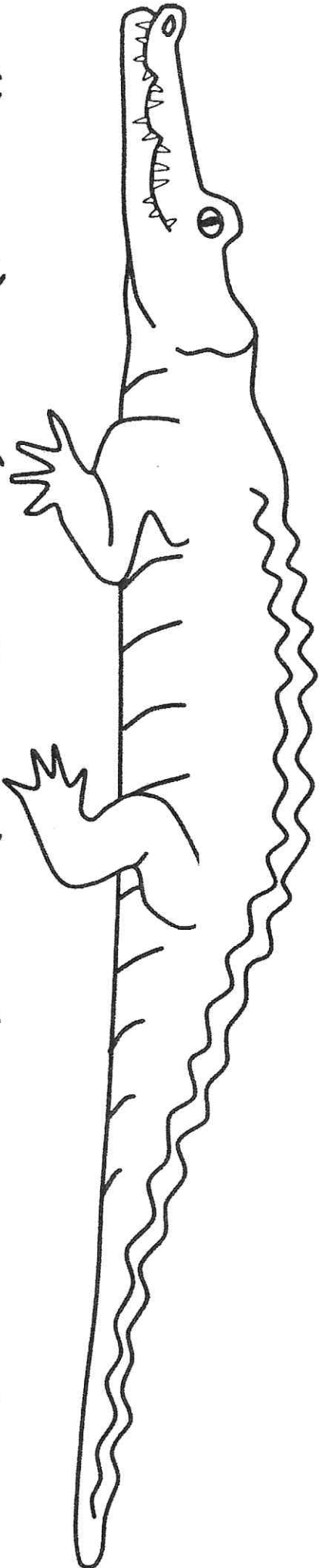

Pencil control 5

Name: _____

Carefully trace over the dotted lines.

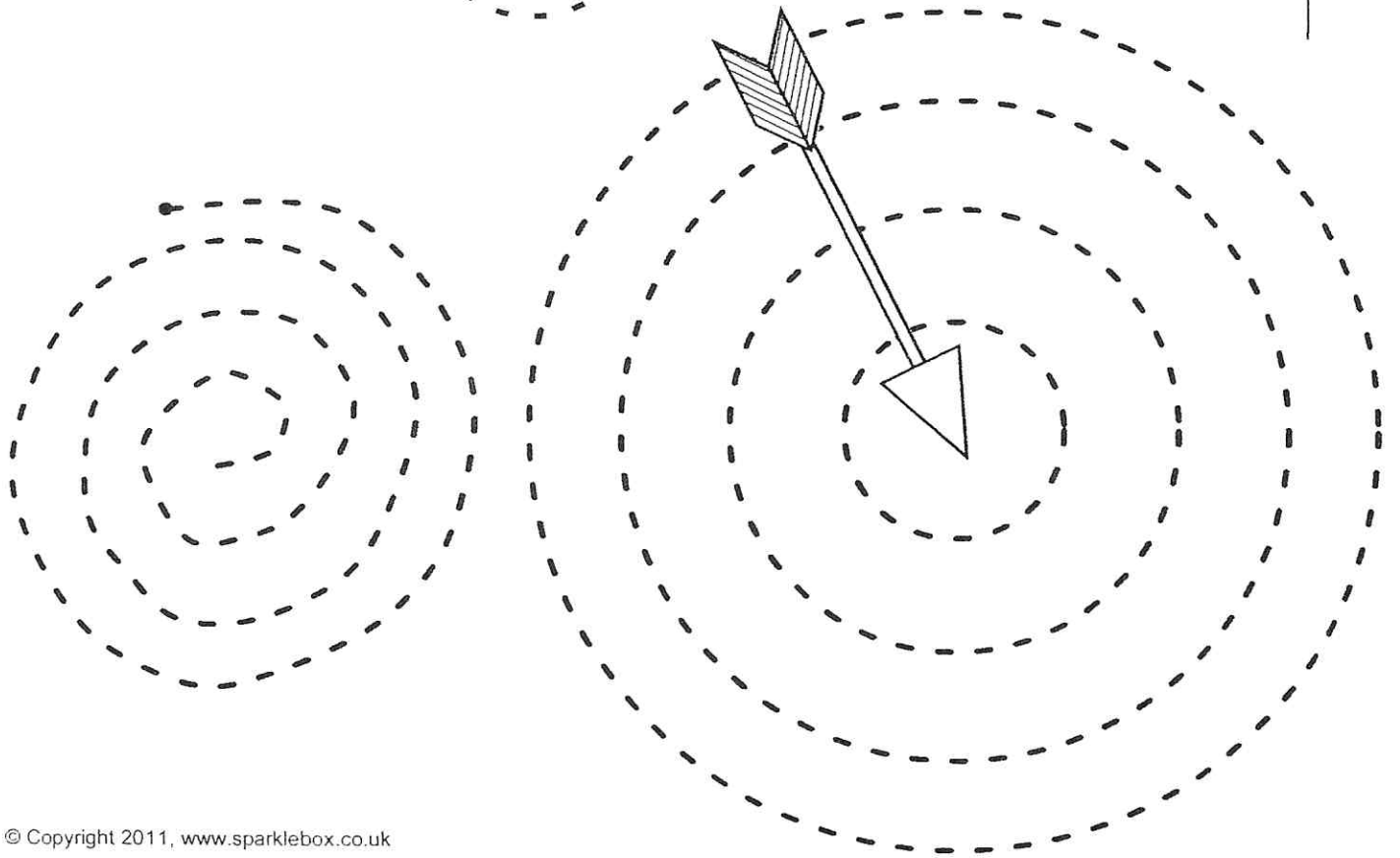
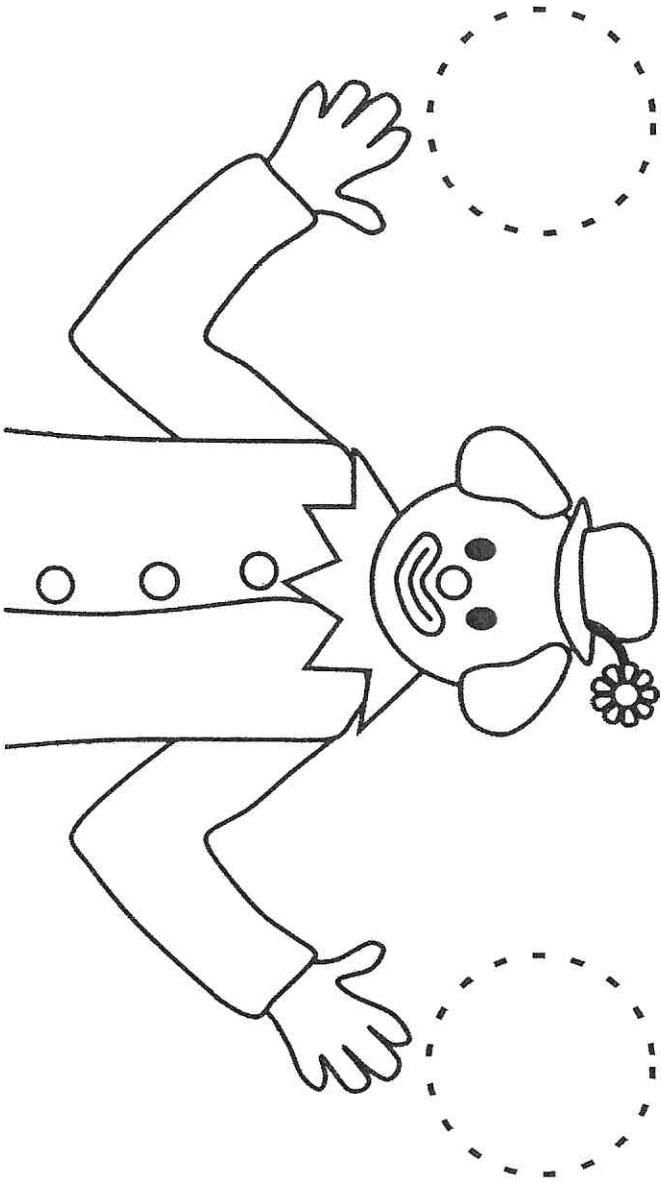

Pencil control 6 Name: _____

Carefully trace over the dotted lines.

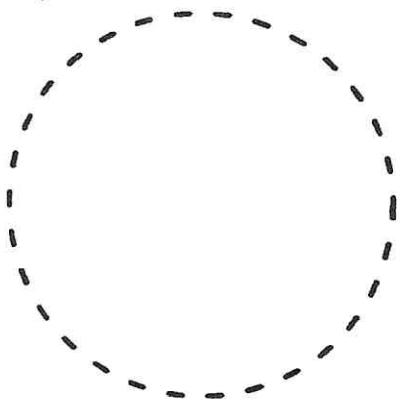
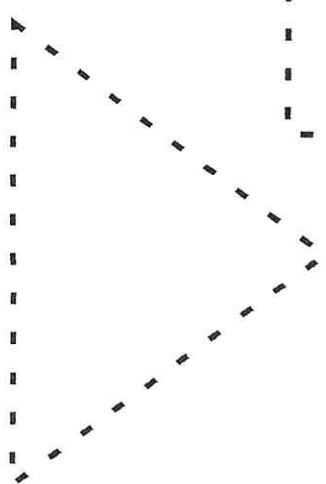
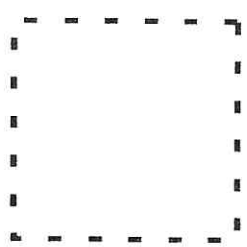
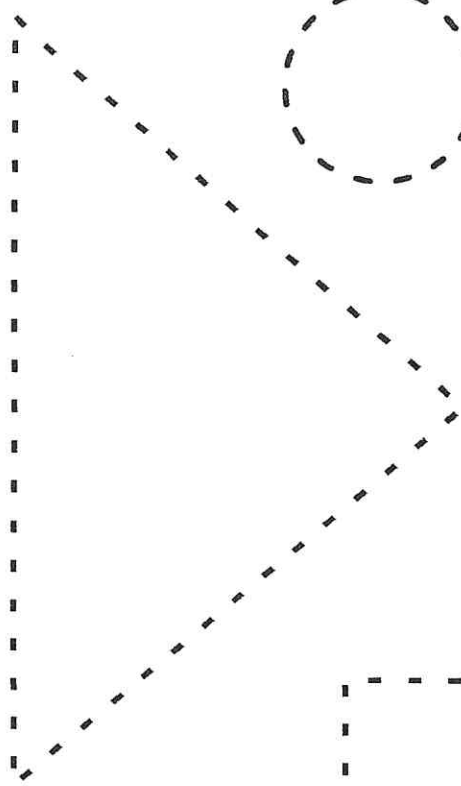
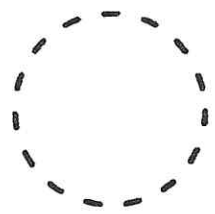
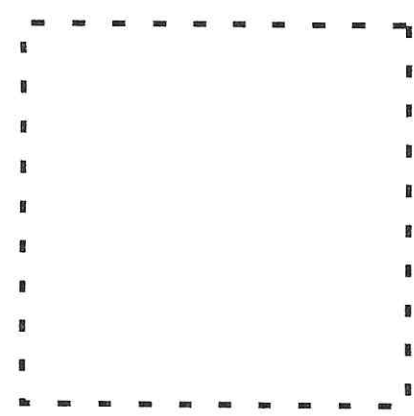
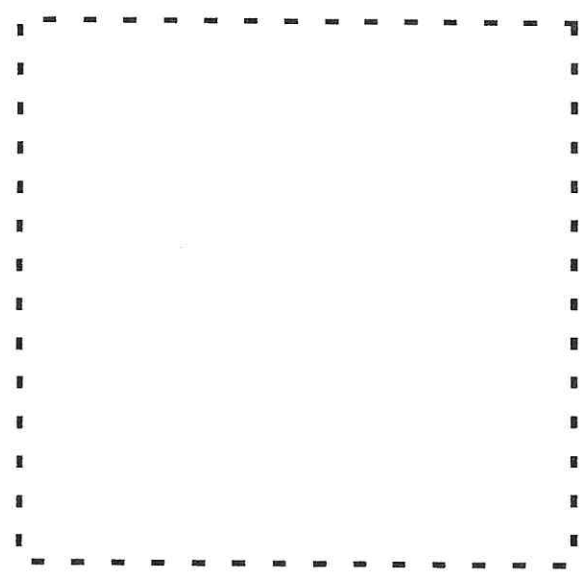
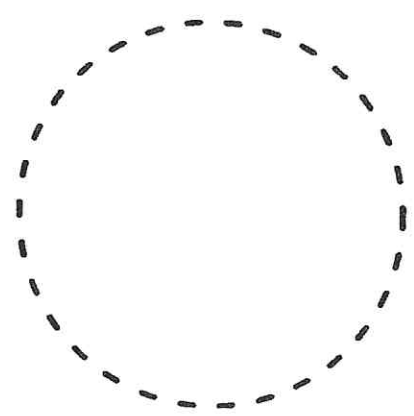
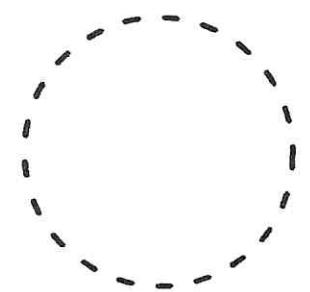
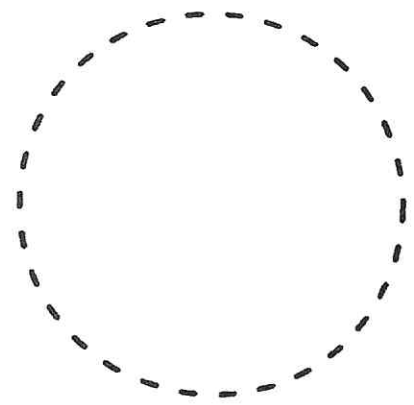
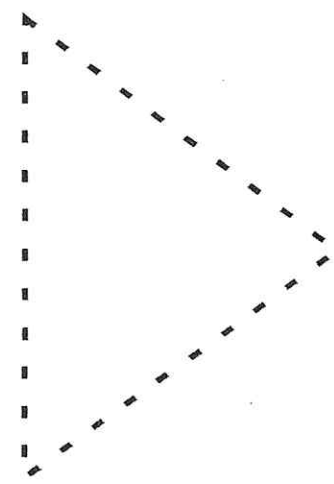

Pencil control 7

Name: _____

Carefully trace over the dotted lines.

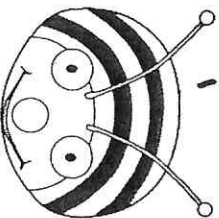
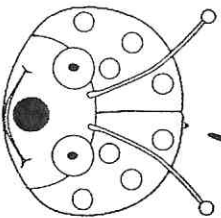
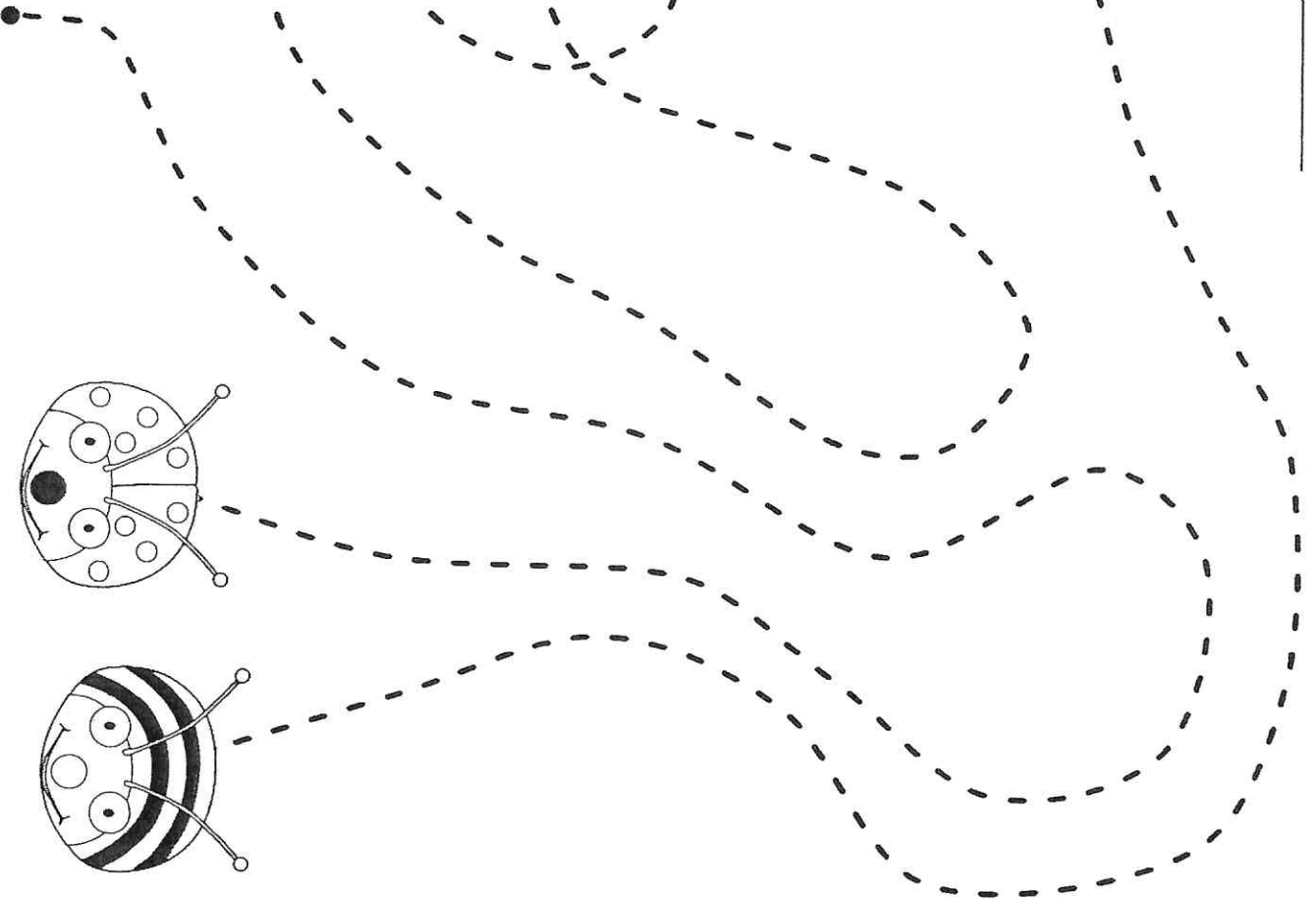
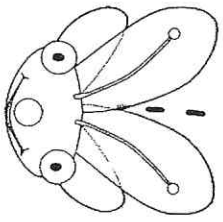
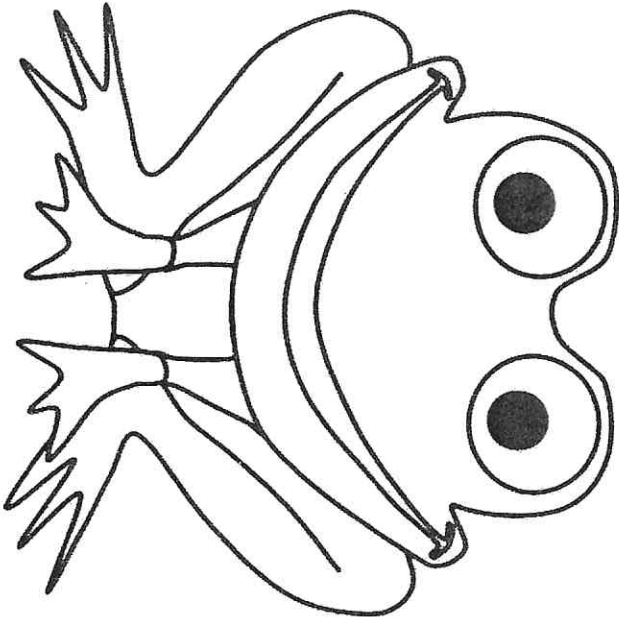

Pencil control 8

Name: _____

Carefully trace over the dotted lines.

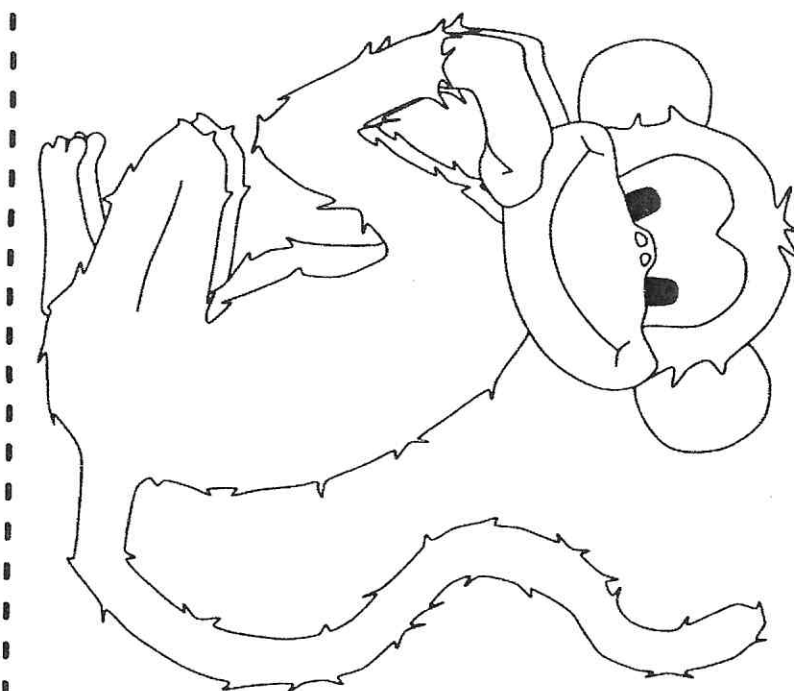

Pencil control 9 Name: _____

Carefully trace over the dotted lines.

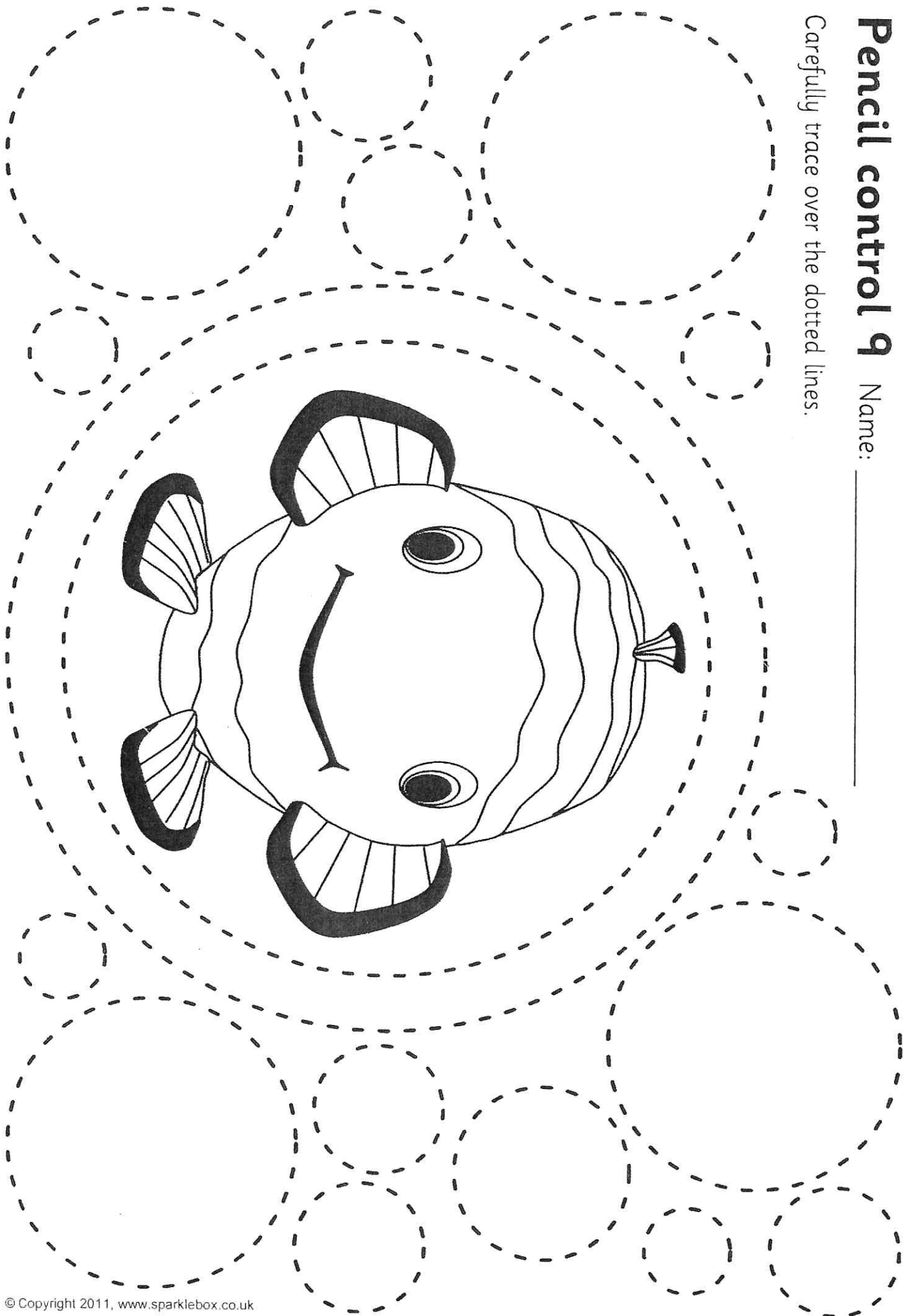

Pencil control 10

Name: _____

Carefully trace over the dotted lines.

